

Technical data

Classification	Electro-medical equipment Class I type B (CEI EN 60601-1/1998, par.5) Class IIb (CCE 93/42, annex IX)	Additional collimators	31 x 41 mm and 22 x 35 mm rectangular, for size 2 and size 1 sensors
Generator	Constant potential, microprocessor controlled	Total filtration	2.5 mm Al
Operating frequency	145 - 230 KHz (175 KHz typical)	Line voltage	50/60 Hz, 115V ± 10% or 230V ± 15%
Focal spot	0.4 mm, (IEC 336)	Duty cycle	self regulating, continuous operation up to 1s/60s
Anode current	6, 7 mA	Stability	Automatic touch-sensitive lock-on/lock-off (HyperSphere)
Voltage (kV setting)	60, 63, 65 kV	Arm extension	Available in 3 lengths: 40 cm – 60 cm – 90 cm
Exposure Time	0.010 – 1.000 sec, R10 and R20 scale	Max arm extension	230 cm, from wall
Source-skin distance	30 and 20 cm (12" and 8") round, 30 cm (12") rectangular	Certification	CE 0051, cCSAus, FDA approved
Irradiated field	35 x 45 mm rectangular, Ø 55 mm or Ø 60 mm round		

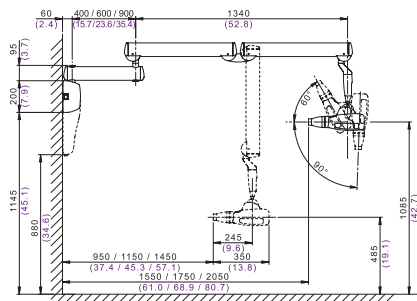
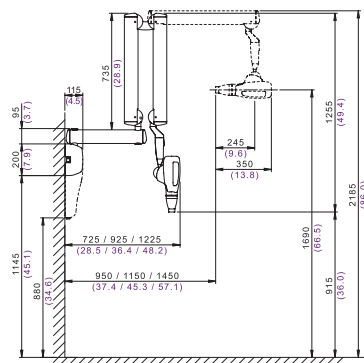
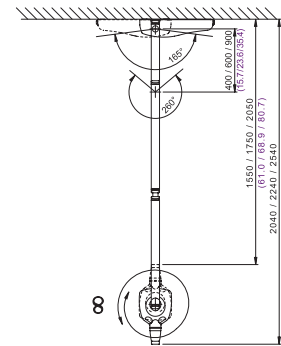
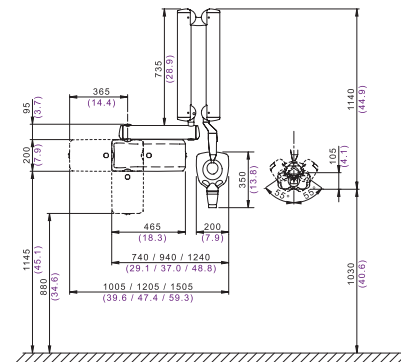

MRXPG091S00

2009/10/15

Data subject to change without notice



RXDC HyperSphere+
Precision X-ray imaging
Touch activated, wireless control

RXDC

High frequency X-ray unit
HyperSphere Technology

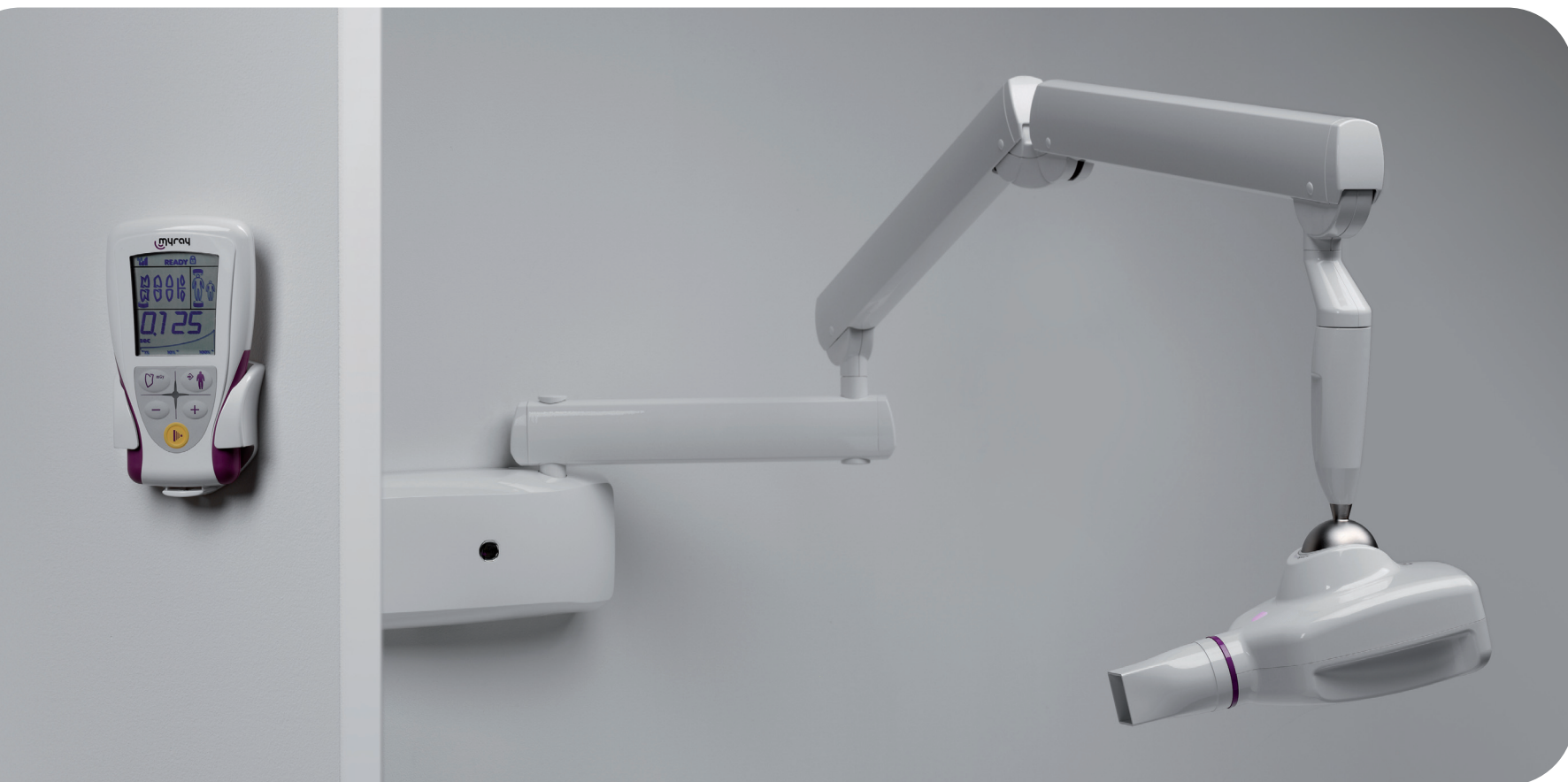

Precision imaging

Specifically conceived for digital X-ray imaging, the constant potential tube head combined with the smallest focal spot available for intraoral imaging (0.4 mm) guarantees consistently sharp images.

Health and Safety

RXDC, with its constant potential high frequency X-ray generator, significantly reduces radiation dosage compared to traditional X-ray units. Not only is the most harmful, low-energy radiation almost completely eliminated thanks to the high-efficiency generator, but the embedded 12" rectangular collimator minimizes the exposed bodily surface and increases the X-ray parallelism. This leads to better image quality and higher regard for patient's health.



MyRay Multi-Mode

Totally automatic choice of the most appropriate combination of technical factors. KV, mA and exposure time are determined according to patient size and anatomic region of interest.

Simple wireless control

One handheld wireless digital control device allows you to program the unit from wherever you are in the surgery. There are no other wall-mounted or wired control panels to worry about. Easy-to-use and easy-to-handle, the control device offers a full range of intuitive exposure scenarios designed to make correct X-ray acquisition a straightforward process. No more complex programming or button-crowded panels. RXDC defines automatically the correct exposure by selecting the region of interest.



Touch-sensitive zones

2 conveniently placed touch-sensitive zones unlock the tube head for quick and easy positioning. As soon as the operator lets go, the tube head locks into place with great precision.

RXDC features HyperSphere technology. The full-swivel ball-joint is revolutionary in every sense. The tube head revolves freely around the sphere, so that practically any position can be achieved, including vertical. An automatic touch-sensitive lock-on/lock-off device enables effortless repositioning of the tube head between exposures.

Comfortable grip

Ergonomically shaped areas on either side of the tube head make rapid positioning easy and effortless to achieve. Right at your finger tips.

Lightweight and compact

RXDC is equipped with a 12" X-ray collimator almost entirely integrated into the tube head body. This makes the tube head itself a more compact lightweight component than would otherwise be possible.

The unique tube head design, together with the stable aluminium arms, make this unit effortless to manoeuvre.

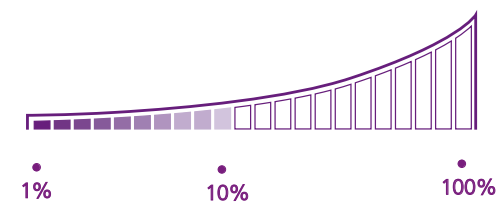

Multiple exposure

RXDC allows uninterrupted use during multiple exposures, such as full-mouth acquisition, thanks to the Dynamic Duty-Cycle, based on real-time control over the bulb temperature, visible on the handheld display.

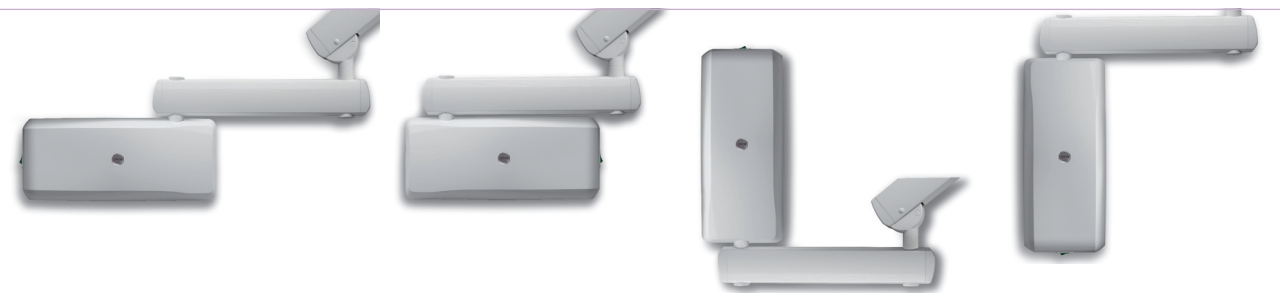

Quality build

Lightweight, solid arms in extruded aluminium with an integrated self-balancing system reduce any risk of tube head vibration during image acquisition.

Great installation versatility and multiple arm lengths available.